

This document is the property of Amphenol Corporation and is delivered on the express condition that is not to be disclosed, reproduced or used, in whole or in part, for manufacture or sale by anyone other than Amphenol Corporation without its prior consent, and that no right is granted to disclose or to use any information in this document.

The marking on this product doesn't contain environmental hazardous material and must follow one or more specifications per Material Specification SS-00259 for Sony GP compliant or per directive 2002/95/EC for RoHS compliant or per IEC 61249-2-21 for Halogen Free compliant.

**PRELIMINARY RELEASE
SUBJECT TO CHANGE**

REVISIONS				
SYM	ECN No.	DESCRIPTION	DATE	APPROVED
AX1		UNAPPROVED REVISION	10/08/2008	Hank Hsu
AX2		MODIFIED DRAWING	12/04/2008	Hank Hsu
AX3		MODIFIED DRAWING	04/24/2009	Hank Hsu

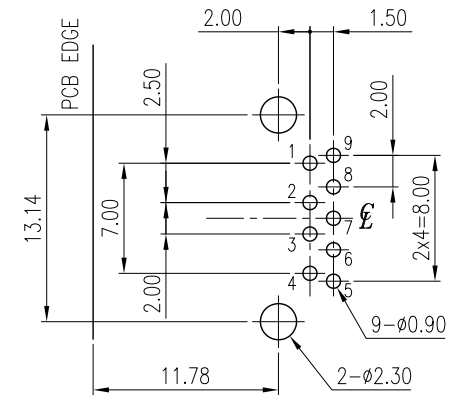
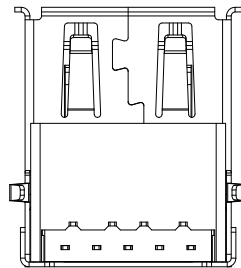
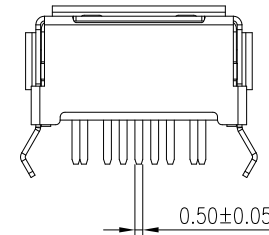
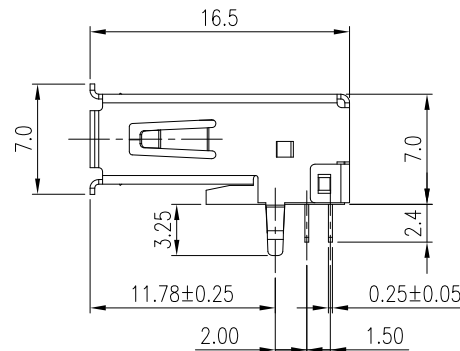
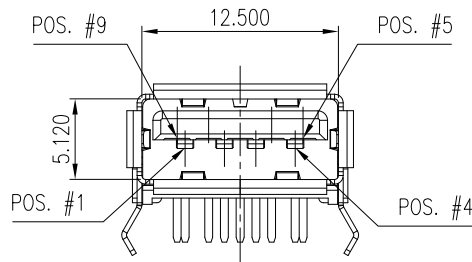
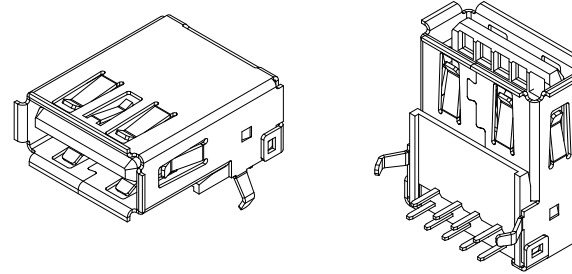
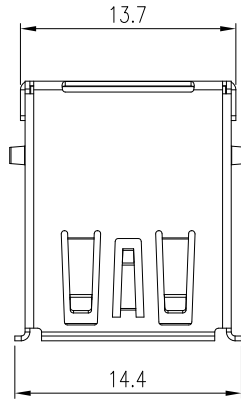

RECOMMENDED PCB LAYOUT- TOP VIEW
(GENERAL TOLERANCE: ±0.05)

NOTES:

- HOUSING: HIGH TEMPERATURE THERMOPLASTIC, UL 94V-0, COLOR- BLUE (PANTONE 300C)
- BOTTOM COVER: HIGH TEMPERATURE THERMOPLASTIC, UL 94V-0, COLOR- BLUE (PANTONE 300C)
- CONTACT: PHOSPHOR BRONZE, 0.25mm THICKNESS, 30µ" MIN. GOLD PLATED ON CONTACT AREA, 100µ" MIN. TIN PLATED ON SOLDERING TAIL, 50µ" MIN. NICKEL UNDER-PLATED OVERALL
- METAL SHELL: COPPER ALLOY, 0.3mm THICKNESS, 100µ" MIN. TIN PLATED ON SOLDERING TAIL, 50µ" MIN. NICKEL UNDER-PLATED OVERALL
- THIS PRODUCT DOESN'T CONTAIN ENVIRONMENTAL HAZARDOUS MATERIALS PER DIRECTIVE 2002/95/EC FOR RoHS AND PER IEC 61249-2-21 FOR HALOGEN FREE COMPLIANT.

TOLERANCE	APPROVALS	DATE	TITLE	UNIT	SIZE	PART No.
X. ±0.30	DRAWN Sondra Sang	04/24/2009	USB 3.0 CONNECTOR STANDARD A R/A DIP TYPE	mm	A3	GSB3 111 31 HR
X.X ±0.20	CHECKER Chenny Yeh	04/24/2009				
X.XXX ±0.10	APPROVED Hank Hsu	04/24/2009		SCALE	SHEET	DWG No.
ANGULAR ±1°	DWG TYPE CUST DWG	PROJECT CODE OTHER		NA	1 OF 1	GSB311131HR
UNLESS OTHERWISE SPECIFIED						REV. AX2

Amphenol®

Amphenol Corporation
Amphenol Taiwan Corporation